

Apple 2 Computer Technical Information

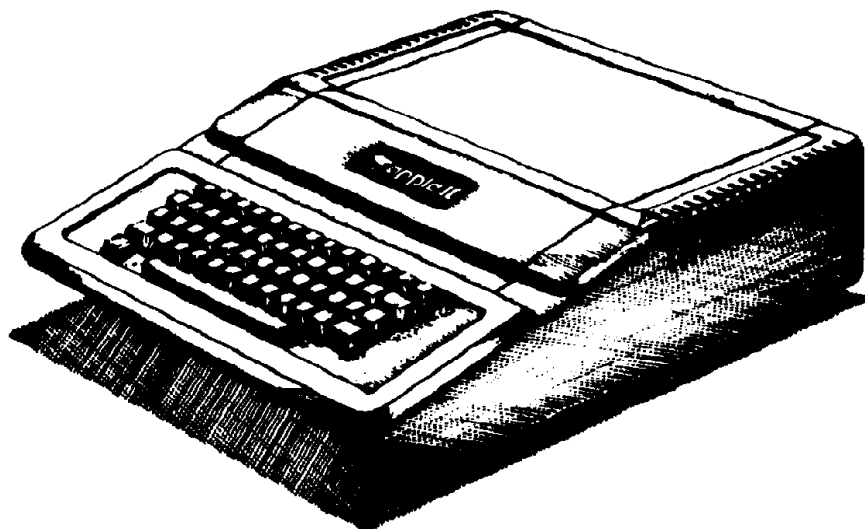

# Apple II Computer Family Information

*Repair Info:*

*Apple 2e Computer*

*Apple May 1989*

Document # **223**

Ex Libris David T. Craig



# Apple 2 Computer Technical Information

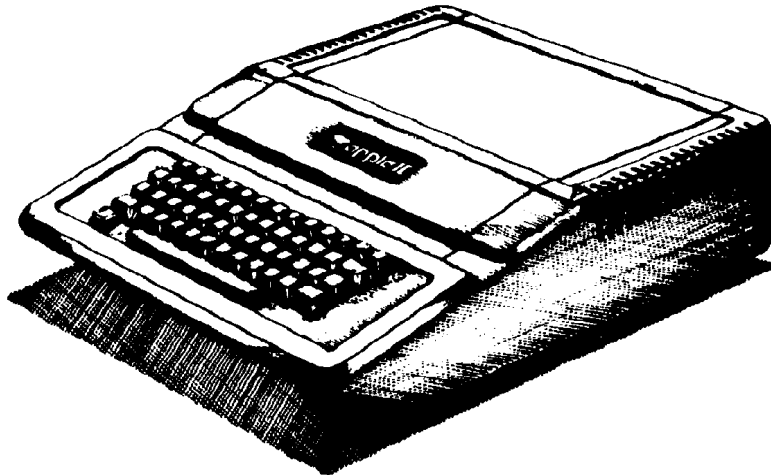

## Apple ][ Computer Family Repair Information

Title

APPLE 2E COMPUTER

Date

MAY 1989

Author

APPLE

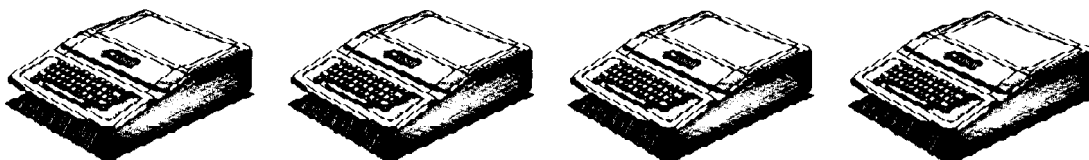

**Apple Technical Repair Procedures  
Table of Contents with Revision Dates**

**Title:** *Apple 2 Family - Apple 2e Computer*

<b>Apple IIe</b>	--Table of Contents	05/89	—
	--Service Notes	09/86	
	(except pages 0.5, 0.7)	08/87	
	(except page 0.6)	06/87	
	--Take-Apart	09/82	
	(except pages 1.1,1.5,1.6,1.7,1.9)	06/85	
	(except pages 1.4, 1.8, 1.10)	10/83	
	--Diagnostics	07/88	
	--Troubleshooting	10/88	
	--Theory of Operations Overview-TS Appendix	05/86	
	--Additional Procedures	07/87	
	--Illustrated Parts List	05/89	
	--Apple II Memory Expansion Card	12/85	
	(except pages 6.1, 6.4)	02/87	
(except page 6.6)	01/86		
--Appendix A	02/87		
--Appendix B	02/87		

*MAY 1989 (5/89)*

 **Apple Technical Procedures**

# Apple IIe

## Technical Procedures

### □ TABLE OF CONTENTS

<b>Section 0 – Apple IIe Service Notes</b>	0.3	Identification – Rev. A, Rev. B, and Enhanced
	0.4	Exchanges of Old Revision A Logic Boards
	0.5	Compatibility of ProFile Interface Cards
	0.5	Case and Keyboard Changes
	0.5	Power Supply Change
<b>Section 1 – Take-Apart</b>	1.4	Opening the Case
	1.5	Removing and Replacing Peripheral Cards and Disk Drive Cables
	1.7	Removing and Replacing the Housing
	1.10	Removing and Replacing the Motherboard
	1.11	Removing and Replacing the Keyboard
	1.12	Removing and Replacing the Power Supply
<b>Section 2 – Diagnostics</b>	2.2	Introduction
	2.2	General Information
	2.2	Before You Start
	2.2	Built-In Diagnostics
	2.3	Things To Remember
	2.5	Apple II Diagnostic Diskette
	2.5	Materials Required
	2.5	Main Menu
	2.6	Choose Tests
	2.8	Options
	2.8	Special
	2.9	Running the Diagnostic
2.12	Test Failures	
<b>Section 3 – Troubleshooting</b>	3.2	Introduction
	3.2	General Information
	3.2	Before You Start
	3.2	How to Use the Symptom Charts
	3.3	Things to Remember
	3.3	Logical Troubleshooting
	3.4	Modules and Functions
	3.6	Apple IIe Symptom Chart

<b>Section 4 – Additional Procedures</b>	4.3	Apple IIe Enhancement Kit Upgrade
	4.6	Single-Wire Shift-Key Modification
<b>Section 5 – Illustrated Parts List</b>	IPL.3	Finished Goods Assembly, Beige
	IPL.5	Platinum Case and Extended Keyboard
	IPL.7	Logic Board
	IPL.7	Power Supply Switch
	IPL.9	Power Supply
	IPL.9	Spacebar Stabilizer Assembly
<b>Section 6 – Memory Expansion Card</b>	6.3	Introduction
	6.4	Things to Remember
	6.6	Diagnostics and Troubleshooting
<b>Appendix A –</b>	A.1	Keyboard and Keyswitch Identification
<b>Appendix B –</b>	B.1	Apple II Plus and Apple IIe: Differences

©Apple Computer, Inc., 1985-1989. No portion of this document may be reproduced in any form without the written permission of Apple Computer, Inc.

UniDisk is a trademark of Apple Computer, Inc.

ProDOS, DuoDisk, Disk II, Apple, and the Apple logo are registered trademarks of Apple Computer, Inc.

Apple IIe Technical Procedures

Section 1

Take-Apart

Contents:

Opening and Replacing the case.....1.2  
Removing and Replacing Peripheral Cards  
and Disk Drive Cables.....1.2  
Removing and Replacing the Housing.....1.5  
Removing and Replacing the Motherboard.....1.8  
Removing and Replacing the Keyboard.....1.9  
Removing and Replacing the Power Supply.....1.10

**Note:** Different versions (revisions) of the motherboard are mounted in different ways to the base. This module will show you only one mounting, but it should be easy to adjust to the others. All other instructions apply to all revisions of the motherboard.

There are also differences between the backplates. The later Apple IIe's do not require clamps for the disk drive cables or nutplates for the DB connectors.

The keyboard is attached to the upper housing in the new version of the Apple IIe case. (In earlier versions, the keyboard is attached to the base.)

For these procedures you will need:

Phillips head screwdriver  
Flat blade screwdriver  
Wrench (p/n 919-0007)

**A. OPENING THE CASE**

1. Power down and disconnect the power cord.
2. Remove Apple lid.
3. Touch the power supply to release any static build-up.

**B. REMOVING AND REPLACING PERIPHERAL CARDS AND DISK DRIVE CABLES**

**Removing Peripheral Cards and Disk Drive Cables**

1. Remove the disk interface card from slot 6.
2. Unplug the disk drive cable connectors from the interface card.
3. To remove the disk drive cable from the back panel, remove the two Jack screws from the clamp (See Figure 1), slide the cable out of the clamp (See Figure 2), and pull the cable out of the opening in the back panel.

**FIGURE 1**

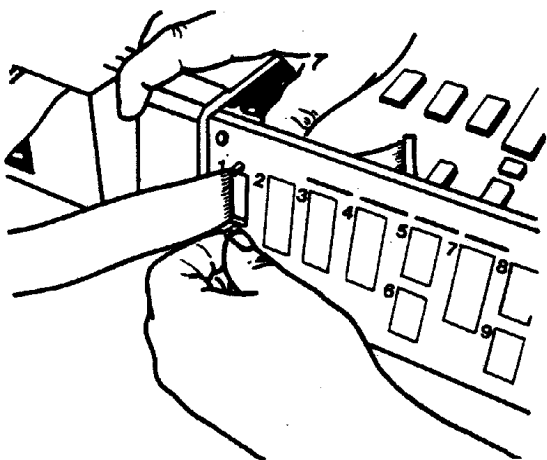

**FIGURE 2**

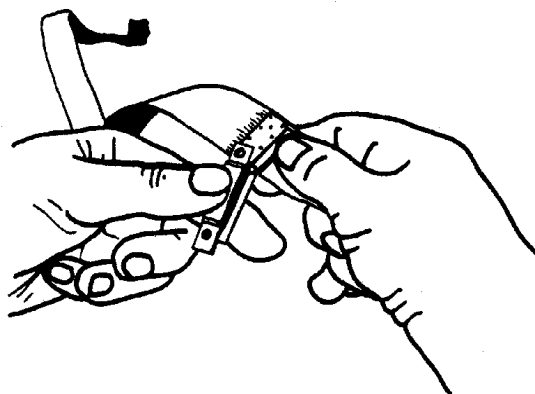

### Replace Disk Drives Cables

1. Slide the disk drive's cable through the lowest numbered opening of the back of panel.
2. Take hold of the cable and bend the flap away from the connector. Hold the flap against the cable with your thumb.
3. Hold the clamp in your other hand so the side with the raised section is under your thumb and the opening in the clamp is pointing up (See Figure 3).

FIGURE 3

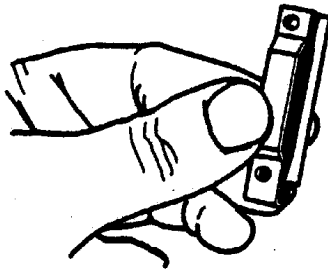

4. Slide the cable and folded over metal flap into the clamp so that the flap is pressed against the cable and sandwiched between the two sides of the clamp (See Figure 4).

**NOTE:** You may have to spread the clamp open slightly to make room for the flap.

FIGURE 4

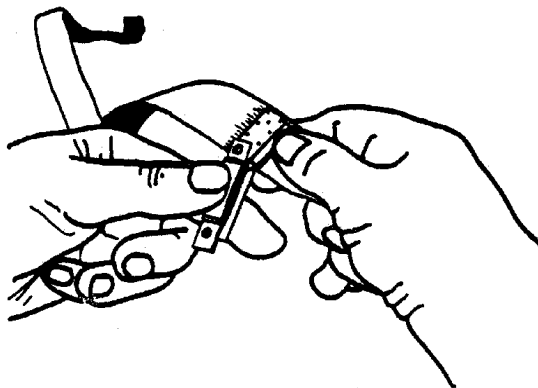



5. Feed the cable back through the opening until the clamp touches the back panel. Push the clamp against the back panel so that the raised section fills the opening and the two round nuts that are affixed to the clamp are facing you (See Figure 5).

**NOTE:** In order to arrange the clamp so it's flat against the back panel, you may have to bend the cable into an "L" shape at the drive side of the clamp.

FIGURE 5

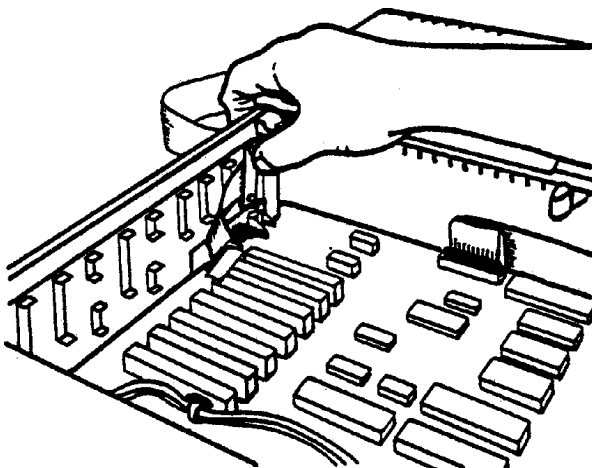

6. Hold the clamp against the opening with one hand. Reach behind the computer with the other hand and install the two screws through the two slots on the top and bottom of the opening and into the nuts on the clamp.
7. Plug the disk drive cable connectors into the interface card.
8. Insert the disk interface card into slot 6.

**C. REMOVING AND REPLACING THE HOUSING**

1. Open the case (Section A, p.1.2) and remove the peripheral cards and disk drive cables (Section B, p.1.2).

**NOTE:** On the new version of the Apple IIe case, the keyboard is attached to the upper housing (rather than to the base). Before the housing can be separated from the base, the keyboard ribbon cable must be disconnected from the motherboard.

2. Turn the Apple upside down resting the keyboard on a protective pad.
3. Remove the ten round head screws from the periphery of the base (See Figure 6, #1). (**Note:** The new Apple IIe case has only nine screws.)

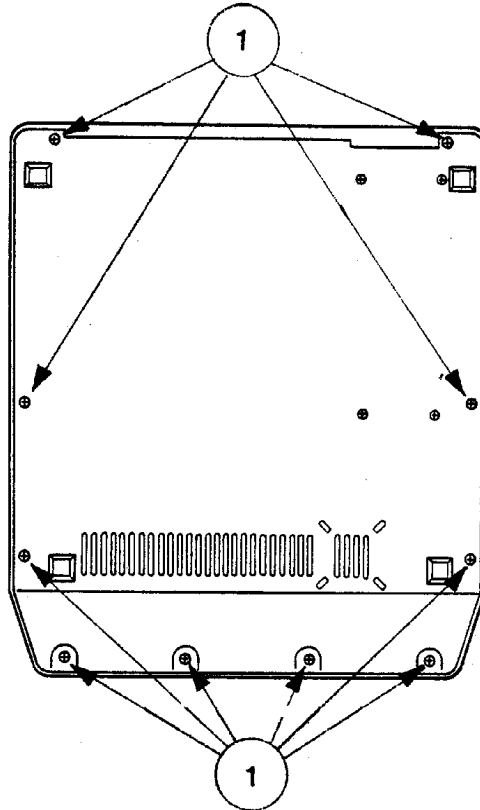
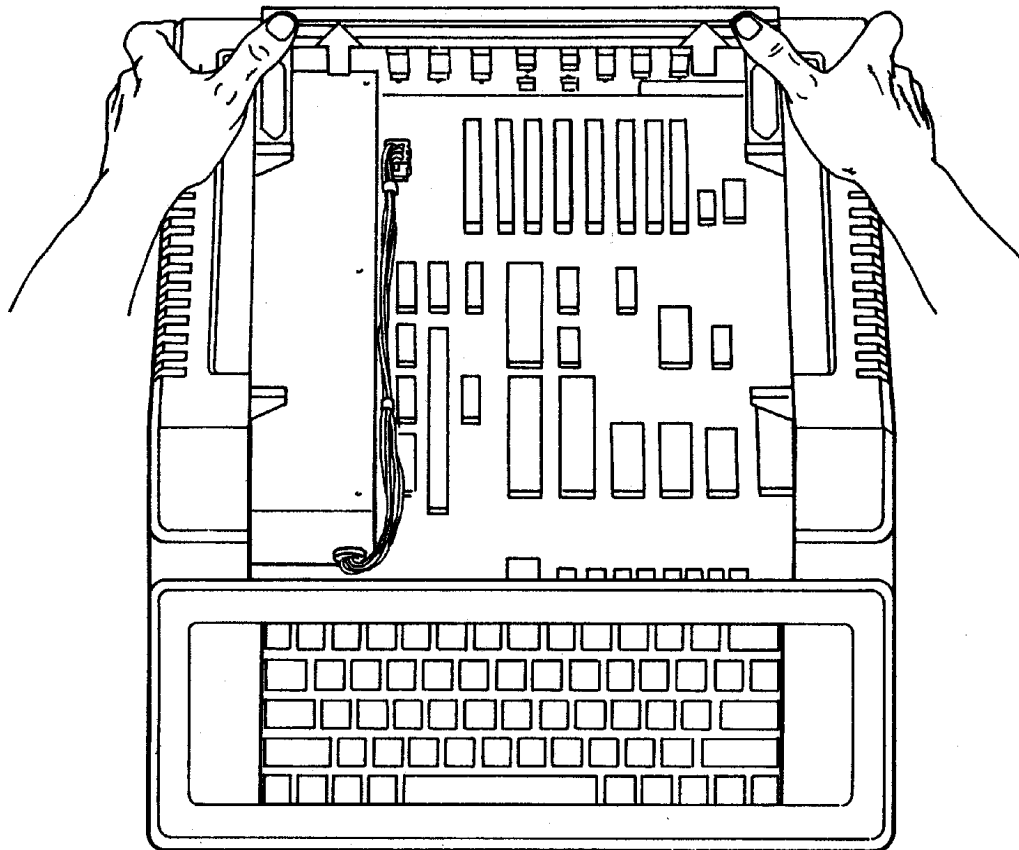

**FIGURE 6**

4. Turn the computer right side up.
5. Remove the two screws that are in the upper right and left corners of the back panel. (These two screws are absent in the new case.)

6. To free the housing on older versions, push back on the thin metal back plate until it is free from the horizontal bar which is part of the housing (See Figure 7, #1). Gently lift the housing off the base.

**NOTE:** In the new case, the metal back plate nests into the horizontal bar running across the back of the upper housing. Since the horizontal bar forms a cap over the back plate, the upper housing is freed by lifting straight up.



**FIGURE 7**

### Replacing the Housing

1. Slide the housing over the base. For replacing older cases, flex the back metal plate backwards to ease it over the back plastic bar of the housing. It is not necessary to flex the metal back plate of the new case version -- simply settle the upper housing over the base, making sure the end of the keyboard ribbon cable is inside the case area.

**NOTE:** On the older case versions, be sure the keyboard cable remains in the box, is properly folded, and is lying flush against the outside of the keyboard stand. Also, be sure the keyboard sits freely in the housing. In particular, check the reset key to see that it does not stick after it has been pressed down.

2. Turn the computer upside down, resting the keyboard on the protective pad.
3. Replace the ten (or nine) screws that attach the housing to the base.

**NOTE:** When replacing the screws put in all of them partway, and then, starting from front to back, secure them tightly.

4. Turn the computer right side up.
5. For older case versions, replace the two screws in the upper left and right corners of the back panel.

**D. REMOVING AND REPLACING THE MOTHERBOARD**

**Removing the Motherboard**

1. Remove the housing from the Apple, (Section C, p.1.5).
2. Pinch the left and right sides of the power supply plug and pull the plug from the top of the motherboard. (See Figure 8, #1).
3. Unplug the speaker connector. (See Figure 8, #2).
4. Remove the keyboard cable. (See Figure 8, #3).
5. Remove the four screws across the back of the motherboard. (See Figure 8, #4).
6. Using a flat blade screwdriver push in on the flanges of the six stand-offs: three across the middle and three toward the front of the motherboard.
7. Carefully slide the board forward; then lift the board up and out.

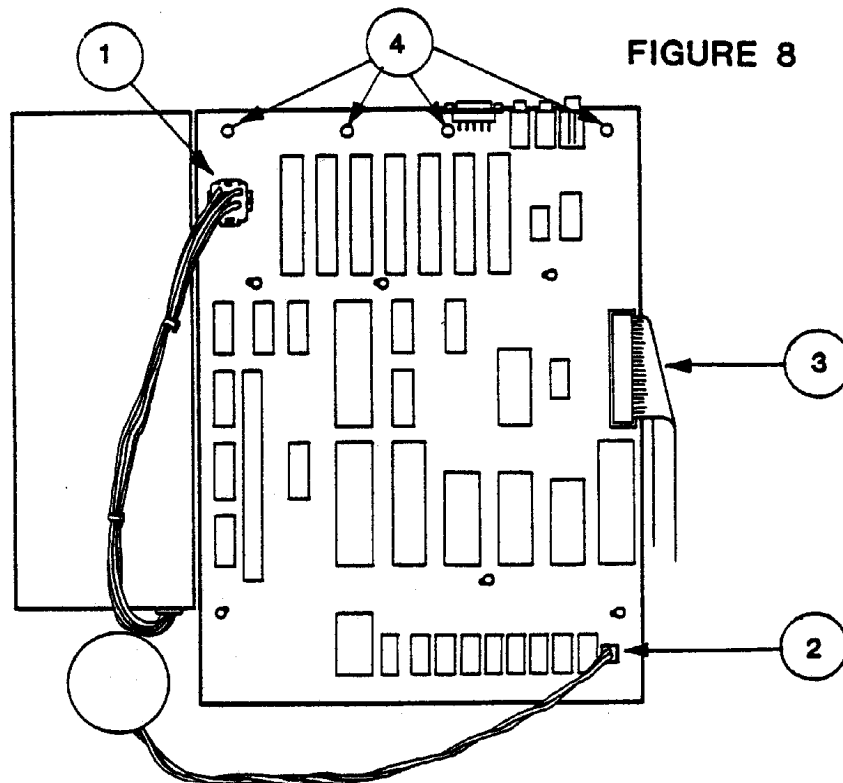

**FIGURE 8**

### Replacing the Motherboard

**NOTE:** See "Section 0. Apple IIe Service Notes" for module exchange information on all Rev. A Logic Boards.

1. Place the motherboard over the six stand-offs and press the board down into place.
2. Replace the four screws across the back of the motherboard.
3. Plug in the speaker connector.
4. Plug in the power supply.
5. Plug in the keyboard cable.

## E. REMOVING AND REPLACING THE KEYBOARD

### Removing the Keyboard

1. Remove the housing from the Apple (Section C, p.1.5).
2. Remove the four Phillips head screws which hold the keyboard in place on the keyboard stand.

**NOTE:** In the new case version, the keyboard is attached by four Phillips screws to the upper housing, rather than to a keyboard stand on housing base plate.

3. Lift the keyboard free.

### Replacing the Keyboard

1. For older case versions, place the keyboard on the keyboard stand. For the new case version, set the keyboard in the upper housing.
2. Replace the four screws to attach the keyboard to the stand (or, in the new version, to the upper housing).

**F. REMOVING AND REPLACING THE POWER SUPPLY**

**Removing the Power Supply**

1. Open the Apple case (Section A, p. 1.2).
2. Unplug the power supply from the motherboard.
3. Set the base on its side.
4. While steadying the base and power supply with one hand remove the four screws with lock washers from the base.
5. Remove base from power supply.

**Replacing the Power Supply**

1. Align power supply with base.
2. Replace the four round head screws with washers.
3. Turn the base right side up.

🍏 Apple Technical Procedures

# Apple IIe

## Section 2 – Diagnostics

---

### □ CONTENTS

2.2	Introduction
2.2	General Information
2.2	Before You Start
2.2	Built-In Diagnostics
2.3	Things To Remember
2.5	Apple II Diagnostic Diskette
2.5	Materials Required
2.5	Main Menu
2.6	Choose Tests
2.8	Options
2.8	Special
2.9	Running the Diagnostic
2.12	Test Failures



## □ INTRODUCTION

### General Information

This section describes general procedures for using the 3.5- or the 5.25-inch *Apple II Diagnostic* diskette on the Apple IIe. This diagnostic allows you to select the tests you wish to run and the order in which you wish to run them. It also allows you to run a continuous test and keep a record of any error codes that may occur. This record will prove valuable for pinpointing problems that cause intermittent failures.

**Note:** On the unenhanced IIe, this diskette will produce strange characters and screens, due to the use of MouseText in the programming of the diagnostic.

### Before You Start

Read *Things to Remember* before you run the diagnostics. It will give you specific hints for using the diagnostic.

### Built-In Diagnostics

Before attempting to boot the diskette-based diagnostics, run the built-in diagnostics. To run them, hold down the <Open-Apple> and <Closed-Apple> keys while turning on the power. (To run the built-in diagnostics if the power is already on, hold down <Control>, <Open-Apple>, <Closed-Apple>, and <Reset>. Release <Reset> first, then the other keys.)

The screen will display various patterns for approximately one minute. The RAM, ROM, and other components on the logic board are being tested.

### Results

The results are displayed in the lower left corner of the screen. "System Good" is accompanied by a high-toned beep, "System Bad" by a low-toned beep.

### System Good

If you can access the built-in diagnostics and you receive the message "System Good," connect a disk drive and continue with this section.

### System Bad

If you cannot access the built-in diagnostics or if you receive the message "System Bad," exchange the keyboard or logic board and try again.

---

**□ THINGS TO REMEMBER**

1. Make a backup diskette before beginning! When testing a defective Apple IIe, it is possible to erase and/or damage a section of the diskette. The *System Utilities* diskette (rev. 2.1 or higher) is used for making a backup copy. Follow the instructions in the *System Utilities Manual*.
2. When loading or saving selected test sequences to diskette, use only a known-good system and disk drive.
3. Where input is required to start the next test (after video test, for example), press <Spacebar>. If you press <Escape>, the testing will stop.
4. The standard keyboard is automatically selected on power up. If you have the extended keyboard, you must select it.
5. To abort the keyboard test, hold down <Control> and press c.
6. To make a selection, type the letter of the test or use the arrow keys until the selection is highlighted, and then press <Return>.
7. When chosen, the tests display a number (1, 2, 3, etc.). This number indicates the order in which the tests will be performed.
8. To deselect a test, type the letter of the test or use the arrow keys until the selection is highlighted; then press the <Delete> key. The numbers displayed will be corrected automatically. To deselect all tests, hold down <Open-Apple> and press <Delete>.
9. To access the Help screen, hold down <Open-Apple> and <Shift>, and press ?.
10. For information on testing the Memory Expansion Card, refer to Section 6, Apple II Memory Expansion Card.

11. If you attempt to run the Disk Card Test using a write-protected diskette, the testing will stop and an error message will be displayed. If this occurs, write-enable the diskette, reboot the Apple IIe diagnostic, and rerun the Disk Card Test.
12. When running the Character Generator Test and using a ColorMonitor IIe or Composite Monitor IIe, the video display shifts left and right and toggles between color and monochrome. (This is the normal result of the method used to display the Character Set Test.)

To make the display easier to view, depress the White-Only switch during the Character Generator Test, and release the switch during all other tests.

## □ APPLE II DIAGNOSTIC DISKETTE

### Materials Required

*Apple II Diagnostic* diskette (5.25- or 3.5-inch)  
 Extended 80-Column Card  
 Known-good 5.25- or 3.5-inch disk drive (DuoDisk,  
 Disk II, UniDisk/Apple 5.25 Drive, or UniDisk 3.5)  
 Apple IIe (enhanced or unenhanced)

### Main Menu

The *Apple II Diagnostic* diskette main menu is shown below.

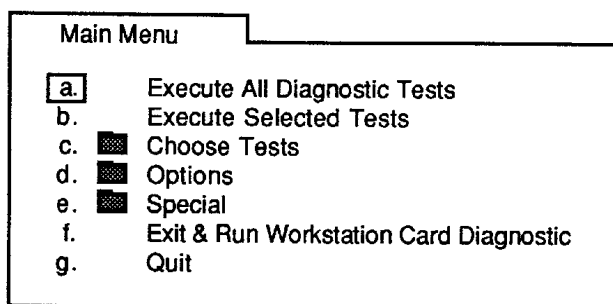

The following list describes each item in the main menu:

**Execute All Diagnostic Tests** - Runs the standard Apple IIe test sequence.

**Execute Selected Tests** - Runs the tests selected in Choose Tests.

**Choose Tests** - Contains all the tests that can be selected for the Apple IIe.

**Options** - Contains various selections that allow you to control how the tests are run.

**Special** - Contains various options for keeping track of errors generated, for saving a test sequence, and for loading a test sequence from diskette.

**Exit & Run Workstation Card Diagnostic** - Terminates the Apple IIe diagnostic and starts the Apple II Workstation Card diagnostic.

**Quit** - Stops all testing and displays a message to reboot the system.

**Choose Tests**

The following list describes the items in the **Choose Tests** folder:

**ROM/CPU Test** - Checks the ROM and CPU.

**System Interrupts Test** - Checks that the interrupts are functioning correctly.

**MMU/IOU Test** - Checks the Memory Management Unit and the Input/Output Unit.

*RAM Tests Folder*

**RAM Tests** - This folder contains the following:

- Main Logic Board RAM Test - Checks the 64K RAM on the logic board.
- Extended 64K/80-Column Card RAM Test - Checks the RAM on the Apple IIe Extended 80-Column Card (if installed).
- Apple IIe Memory Expansion Card Test - Checks the RAM on the Memory Expansion Card. The card can be installed in any slot except 3. This test will not run unless selected. Refer to Section 6, Apple IIe Memory Expansion Card.

*Disk Drive Tests Folder*

**Disk Drive Tests** - This folder contains the following:

- Disk Card Test - Checks the drive circuitry on the interface cards for all 3.5- and 5.25-inch drives that are attached to the system. The diskette in each drive to be tested must be formatted with ProDOS.

*Sound Tests Folder*

**Sound Tests** - This folder contains the following:

- Speaker Tone Test - Checks the speaker by playing a sequence of beeps.

*Video  
Pattern Folder*

**Video Pattern Tests** - This folder contains the following:

- Color Bar Test - Displays vertical color bars with the name of each color below.
- Character Generator Test - Displays the character set available.

**Note:** When running the Character Generator Test and using a ColorMonitor IIe or Composite Monitor IIe, the video display shifts left and right and toggles between color and monochrome. (This is the normal result of the method used to display the Character Set Test.)

To make the display easier to view, depress the White-Only switch during the Character Generator Test, and release the switch during all other tests.

- 80/40 Column Text Test - Displays a few lines of 80-column characters, then a few lines of 40-column characters.
- Low-Resolution Graphics Test - Displays both pages (one and two) of the low-resolution graphics mode with bars at the top of the screen.
- High-Resolution Graphics Test - Displays a grid of 9 vertical lines intersected by 8 horizontal lines.
- Double High-Resolution Graphics Test - Displays a grid of 18 vertical lines intersected by 8 horizontal lines.

*Keyboard/Mouse  
Folder*

**Keyboard/Mouse Tests** - This folder contains the following:

- Standard IIe Keyboard Test - Displays a keyboard layout for the Apple IIe keyboard. The instructions are given at the bottom of the screen.
- Language - Displays a list of languages available for the keyboard tests. The default setting is U.S.A. English.

- Numeric Keypad Ite Test - Displays a numeric keyboard layout. The instructions are given at the bottom of the screen.
- Joystick/Paddle Test - Displays a pointer that can be moved around the screen and a box that indicates whether the joystick/paddle buttons are pressed or not. If testing paddles, verify that both reach the full range possible (0-FF).

### Options

When the **Options** folder is open, the following list of selections appears on the screen.

Loop Tests Until ESC is Pressed  
Continue On Error Until ESC

If an option is selected, a check mark appears beside the item. To deselect an option, just select the same option again.

### Special

The following selections appear when the **Special** folder is opened.

- Display Error Log - Displays the names of the tests that have failed since the last clearing of the error log (up to 255 names).
- Clear Error Log - Erases the log from RAM.
- Clear Testing Status Line - Clears the iterations and failure counts displayed.
- Display Current System Status - Indicates the type of system, the ROM version, the amount of memory available (number of banks) and the memory card status.
- Load Selected Test Sequence from Disk - Loads a previously saved test sequence. The sequence can then be executed.
- Save Selected Test Sequence to Disk - Saves a test sequence you have selected to the test diskette.

When any of the above items is selected and <Return> is pressed, the action is performed.

## Running the Diagnostics

The diagnostic can be configured in various ways. All the tests can be run in their automatic sequence, or selected tests can be looped or run in an order you specify.

The diagnostic also has the ability to execute a test selection sequence that has been saved to the test diskette. Saved test sequences make it easier to test an Apple IIe that has an extended keyboard or other specially configured systems.

For information on the Apple II Memory Expansion Card refer to **Section 6, Apple IIe Memory Expansion Card**.

## Standard Test

1. Install Extended 80-Column Card in the auxiliary slot.
2. Insert the Apple IIe Diagnostic Diskette and power on the system.
3. Type the letter a or use the arrows to select **Execute All Diagnostic Tests**, and press <Return>.

To continue after certain tests (for instance, Speaker, Video Patterns), press <Spacebar>.

If an error is encountered, the testing will stop and an alert box will appear specifying which test failed.

4. On completion, the message **Testing finished** will be displayed in the alert box.



*Customized Test*

1. Install the Extended 80-Column Card in the auxiliary slot. Install the Apple II Memory Expansion Card in any slot except 3.
2. Insert the Apple II Diagnostic Diskette and power on the system.
3. Type the letter **c** or use the arrows to select **Choose Tests**, and press **<Return>**.
4. From this menu, select the first three tests (if desired) and press **<Return>** to select them. Select the other test folders and press **<Return>** to display them. Select the tests you wish to run from each folder and press **<Return>** to select them.

If you wish to deselect a test, use the letters or arrows to select the test and press the **<Delete>** key.

5. To save your customized test sequence, return to the main menu, and select **Special**. Select **Save Selected Test Sequence to Disk** and press **<Return>**.

You now have the selected test sequence saved to diskette. The sequence may be loaded using **Load Selected Test Sequence from Disk** at a later date when it is needed.

6. On completion, return to the main menu, select **Execute Selected Tests**, and press **<Return>**.

To continue after certain tests (for instance, speaker, video patterns), press **<Spacebar>**.

If an error is encountered, the testing will stop and an alert box will appear specifying which test failed.

7. On completion, the message **Testing finished** will be displayed in the alert box.

### *Continuous Test*

A continuous (looping) test is possible with all tests. Select the tests you wish to loop by following the instructions under "Customized Test" (see above). Follow the steps below to run a continuous test.

1. After you have chosen the tests you want to run, return to the main menu, select **Options**, and press <Return>.
2. From the menu, select **Loop Tests Until ESC is Pressed** and press <Return>.

A check mark should appear, indicating what has been selected.

3. Select **Continue On Error Until ESC** if you want to continue looping, regardless of the error, until <Escape> is pressed.

If you do not select this option, the testing will halt when an error is encountered.

Errors will be logged to RAM.

4. Return to the main menu, select **Execute Selected Tests**, and press <Return>.

The tests will run (depending on your selection in step 3) continuously until an error occurs or <Escape> is pressed. If <Escape> is pressed, looping is canceled.

If you press <Escape> to stop the testing, you can then check for errors by selecting **Special** and pressing <Return>. Then select **Display Error Log**.

5. If you are going to run the continuous test again, be sure to clear the error log and the status line and to reselect **Loop on Error Until ESC is Pressed** before returning to the main menu.

**Test Failures** When a test fails, either a message will appear giving the name of the test that has failed, or the test will be listed in the error log. The following is a list of the tests along with the recommended remedial actions.

<b>Tests</b>	<b>Remedial Action</b>
• <i>ROM/CPU</i>	- Exchange logic board.
• <i>System Speed/Interrupts</i>	- Exchange logic board.
• <i>MMU/IOU</i>	- Exchange logic board.
• <i>Main Logic Board RAM</i>	- Exchange logic board.
• <i>Extended 80-Column Card</i>	1. Exchange card. 2. Exchange logic board.
• <i>Disk Port</i>	1. Exchange drive. 2. Exchange interface. 3. Exchange logic board.
• <i>Speaker</i>	1. Exchange speaker. 2. Exchange logic board.
• <i>All Video</i>	- Exchange logic board.
• <i>Ile Keyboard or Ile Extended Keyboard</i>	1. Exchange cable. 2. Exchange keyboard. 3. Exchange logic board.
• <i>Numeric Keypad</i>	1. Exchange numeric keypad. 2. Exchange cable. 3. Exchange logic board.

**Tests**

**Remedial Action**

- *Joystick/Paddle*

1. Exchange joystick or paddles.
2. Exchange logic board.

- *Apple II Memory Expansion Card*

- Refer to Section 6, Apple II Memory Expansion Card, for more information.

 Apple Technical Procedures

# Apple IIe

## Section 3 – Troubleshooting

---

### □ CONTENTS

3.2	Introduction
3.2	General Information
3.2	Before You Start
3.2	How to Use the Symptom Charts
3.3	Things to Remember
3.3	Logical Troubleshooting
3.4	Modules and Functions
3.6	Apple IIe Symptom Chart

---

## □ INTRODUCTION

### **General Information**

Use this troubleshooting section if the diagnostic is unable to detect a module failure or if the diagnostic diskette cannot be booted. After you repair the system, run the diagnostic test to verify system operation.

### **Before You Start**

Read the section entitled "Things to Remember" before you begin troubleshooting. There are several things you should know about the Apple IIe to troubleshoot the system effectively.

### **How to Use the Symptom Chart**

Use the left column to locate the symptom that best describes the problem of the defective system. For each symptom, perform the corrective action(s) in the order listed. If a corrective action does not fix the problem, proceed to the next step.

If a board is replaced but does not fix the problem, the original board should be reinstalled before you perform the next step.

---

## □ THINGS TO REMEMBER

1. Electrostatic Discharge (ESD) can cause severe damage to sensitive microcircuits. To prevent ESD damage to the Apple IIe components, follow the precautions outlined for ESD prevention under the tab *You Oughta Know*.
2. Be sure the power is off before installing or removing any modules or components, or before connecting or disconnecting any peripheral devices.
3. After powering on the Apple IIe, there is sometimes a 20-to-30-second wait. During this time, "garbage" sometimes appears on the screen. To eliminate this problem, hold down the <Open-Apple> key when turning the system on.

---

## □ LOGICAL TROUBLESHOOTING

Troubleshooting can be approached in many different ways. Apple recommends two methods in particular:

- Logical troubleshooting
- Module swapping in a particular order for a particular symptom

Most troubleshooting charts in the *Apple Service Technical Procedures* are based upon the module-swapping method, but you can often save repair time by using logical troubleshooting before you start swapping.

Logical troubleshooting involves knowing the function of each module in the machine, and using that information to narrow your search for the problem. This section will give you the information necessary to perform logical troubleshooting of the Apple IIe. The information here includes a description of each module in the IIe and the various functions it performs. (For definitions of basic terms, refer to *Simplified Overview of a Microcomputer System* in *You Oughta Know*.)

**Modules and Functions**

*Logic Board*

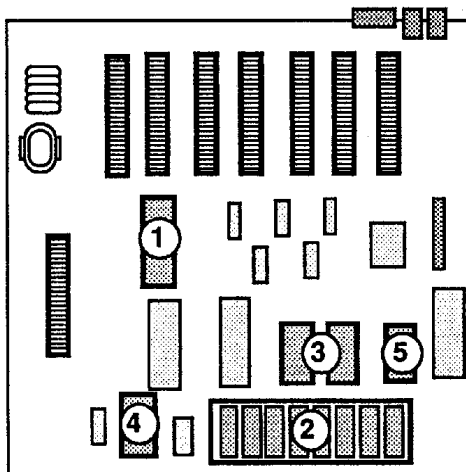

The logic board is the heart of the system. It contains the components described below. A number after an IC in the descriptions below corresponds to a number in the figure above (indicating the location of the component on the Apple IIe logic board). The ICs that have a number are exchangeable.

- The **CPU (1)**, a 6502 microprocessor, gets instructions from memory, translates them, and carries them out. It communicates with all components on the logic board.

**Note:** The IIe is available in an enhanced version. Refer to the *Module Identification Manual* for specific differences between the enhanced and unenhanced Apple IIe logic boards.

- The **Oscillator** (timing device) provides the master clock pulse for all the ICs on the board.
- The **RAM (2)** storage capability (on the logic board) is 64K. Additional RAM can be added by installing various add-on memory cards.
- The two **ROMs (3)**, at coordinates CD and EF, contain the AppleSoft editor and interpreter, the monitor, the 80-column display firmware, and the diagnostic self-test routines.



- The **character generator ROM (4)** changes the input code into the proper bit patterns for use by the external monitor.
- The **keyboard ROM (5)** converts the information into the proper code for the computer to use.
- The seven mail slots are used for plug-in cards, which are necessary to interface with external peripheral devices. For example, any disk drive or printer must be connected to the IIe via an interface card inserted into one of these slots.
- There is one additional slot, the auxiliary slot, which is considered slot 3. This slot is reserved for the 80-column card, RGB card, or a similar card (the card's manufacturer will specify whether the card requires installation in the auxiliary slot).

*Power Supply*

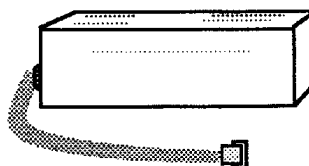

The power supply operates on standard line voltage and outputs various DC voltages, which are used by the logic board and by some peripheral devices (for example, Disk II and UniDisk).

*Keyboard*

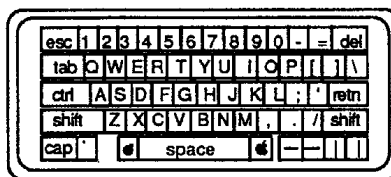

The keyboard information is sent via a cable to the logic board in the form of X and Y coordinates. The coordinates are converted by the keyboard encoder and keyboard ROM into a form that the logic board can use.

## □ APPLE IIe SYMPTOM CHART

### Video Problems

### Solutions

- |   |  |
|---|--|
| <ul style="list-style-type: none"> <li>• <i>No video</i></li> </ul>                                 | <ol style="list-style-type: none"> <li>1. Exchange video cable.</li> <li>2. Exchange RAM.</li> <li>3. Exchange ROM at coordinates CD and EF.</li> <li>4. Exchange logic board.</li> </ol>  |
| <ul style="list-style-type: none"> <li>• <i>Display is fuzzy on a known-good monitor</i></li> </ul> | <ol style="list-style-type: none"> <li>1. Exchange video cable.</li> <li>2. Exchange RAM.</li> <li>3. Exchange ROMs at coordinates CD and EF.</li> <li>4. Exchange logic board.</li> </ol> |
| <ul style="list-style-type: none"> <li>• <i>Garbage displayed on known-good monitor</i></li> </ul>  | <ol style="list-style-type: none"> <li>1. Exchange RAM.</li> <li>2. Exchange ROMs at coordinates CD and EF.</li> <li>3. Exchange logic board.</li> </ol>                                   |

**Peripheral Problems**

**Solutions**

- *Cassette saving problem*
  - Exchange logic board.
  
- *Cassette loading problem*
  - Exchange logic board.
  
- *Keys fail to remove appropriate character from keyboard test on Apple II diagnostic*
  - 1. Exchange keyboard cable.
  - 2. Exchange keyboard.
  - 3. Exchange keyboard ROM.
  - 4. Exchange logic board.
  
- *System locks up intermittently with Extended 80-Column Card installed*
  - 1. Exchange MMU.
  - 2. Exchange Extended 80-Column Card.
  - 3. Exchange logic board.
  
- *Display problem with Extended 80-Column Card installed*
  - 1. Exchange IC 74LS245 on the Extended 80-Column Card.
  - 2. Exchange Extended 80-Column Card.
  - 3. Exchange logic board.
  
- *The special function keys on the numeric keypad do not work properly*
  - If the Apple IIe contains a "revision C" character generator ROM at location E-12 on the logic board, exchange the ROM with any other version from service stock. **Do not replace the entire Apple IIe logic board.**

**Miscellaneous Problems**

**Solutions**

- *Programs run erratically, often crash*

  1. Exchange RAM.
  2. Exchange ROMs at coordinates CD and EF.
  3. Exchange logic board.
  4. Exchange disk drive.
  
- *No beep and no message is displayed; monitor has random characters on screen when the Apple is turned on; drive does not come on*

  1. Exchange ROM at coordinates EF.
  2. Exchange RAM.
  3. Exchange power supply.
  4. Exchange logic board.
  
- *AppleSoft or Integer BASIC errors*

  1. Exchange ROM at coordinates CD.
  2. Exchange RAM.
  3. Exchange logic board.
  
- *No power light; no video*

  1. Exchange AC power cord.
  2. Exchange power supply.
  3. Exchange logic board.
  
- *No audio*

  1. Exchange speaker.
  2. Exchange logic board.
  
- *Diagnostic self-test runs at power on*

  1. Exchange keyboard cable.
  2. Exchange keyboard.
  3. Exchange logic board.
  
- *After exchanging logic board, system locks up and/or hisses*

  - Check speaker (wire may be pierced).

**Apple IIe Technical Procedures**

**Section 4**

**Additional Procedures**

**Contents:**

Apple IIe Enhancement Kit Upgrade.....4.3  
Single-Wire Shift-Key Modification.....4.4

**U.S. VERSION**

**FIGURE 1**

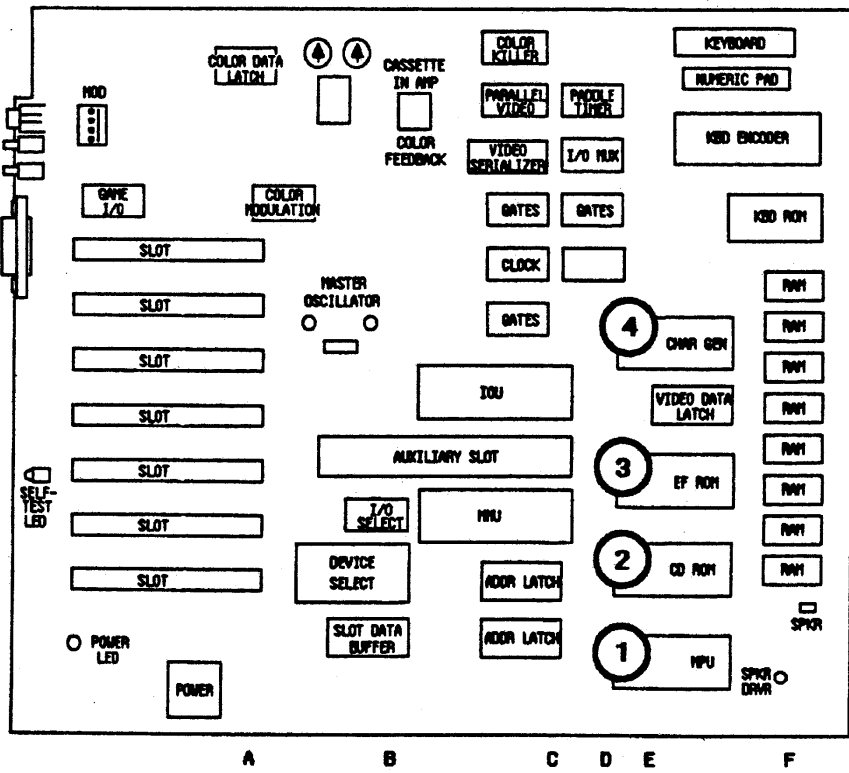
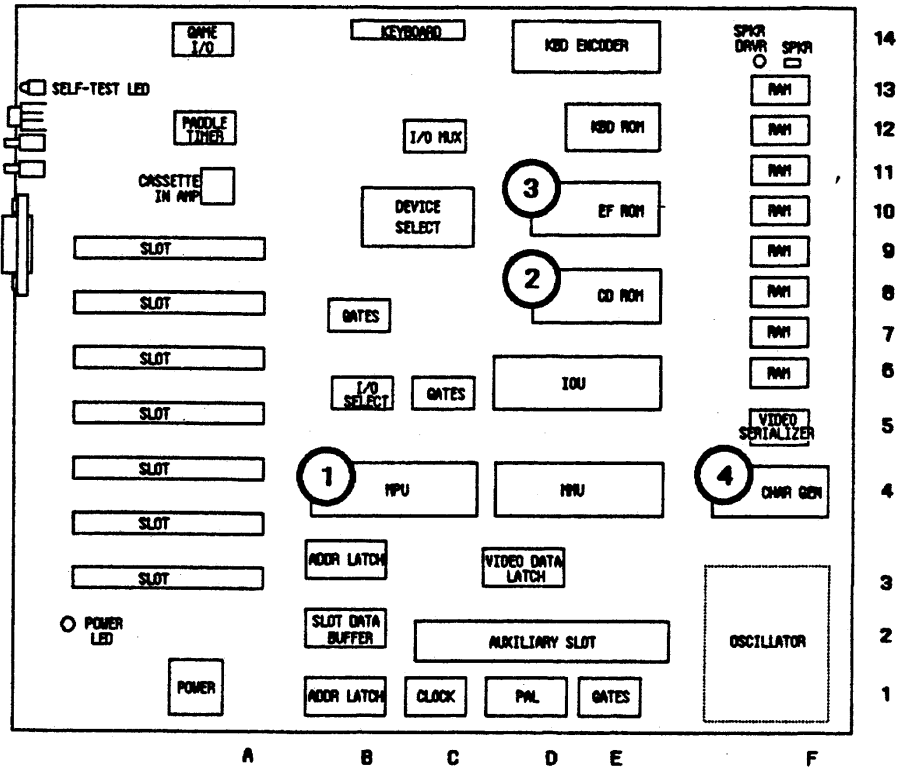

**EUROPEAN VERSION**

**FIGURE 2**

### APPLE IIe ENHANCEMENT KIT UPGRADE

The Apple IIe Enhancement Kit makes an Apple IIe compatible with the advanced features available on the IIc. It allows the IIe to support interrupts for applications and networking. With the kit, the IIe also gains faster processing time and the ability to use the MouseText character display features.

To upgrade your IIe you will need to replace the following four ICs on the logic board:

- 1) The 6502 Microprocessor (P/N 370-6502) is replaced by the 65C02 Microprocessor (P/N 338-6503)
- 2) The CD Monitor ROM (P/N 342-0135) is replaced by the CD Monitor ROM (P/N 341-0304)
- 3) The EF Monitor ROM (P/N 342-0134) is replaced by the EF Monitor ROM (P/N 341-0303)
- 4) The Video (Character Generator) ROM (P/N 342-0133) is replaced by the Character Generator ROM (P/N 342-0265)

See Figure 1, page 4.2 for U.S. IIe logic board layout and location of the ICs. See Figure 2, page 4.2 for European IIe logic board layout and location of the ICs.

The numbers above correspond with the numbers on the appropriate layout.

### Installation Procedures

**WARNING:** The four ICs you will be installing are extremely susceptible to static discharge. Before handling these ICs be sure to touch the metal power supply case to discharge any electricity that may have built up on your body or clothing.

1. Power off the IIe system.
2. Remove the cover and all interface cards.
3. **Touch the power supply.**
4. Referring to Figure 1 on page 4.2 (for the U.S. logic board), or Figure 2 on page 4.2 (for the European logic board) locate the four chips to be replaced.

5. Remove the chips using an IC extractor. For the 6502, use a small, narrow, flatblade screwdriver to gently pry up each end of the IC a little at a time. Be careful that you do not scratch the logic board traces when using the screwdriver.
  6. **Touch the power supply again** to be sure that you are completely discharged.
  7. Identify the new chips and remove them from the piece of antistatic foam. Install each chip at the appropriate location.
- IMPORTANT:** There is a notch at one end of each chip. This notch should face the keyboard on installation.
8. Place the old chips on the antistatic foam.
  9. Replace the interface cards you removed, replace the cover, and run a IIC program to verify that the upgrade works correctly.

#### **SINGLE-WIRE SHIFT-KEY MODIFICATION**

The single-wire shift-key modification, which wasn't present on revisions A and B of the Apple IIe logic board, is now hard-wired. The change was made to allow mouse-based applications to detect a "shifted click" and to allow software that utilized the old single-wire shift-key method to work without modification to the logic board.

**Important:** On X6-jumpered logic boards, never simultaneously depress the shift key and switch 2 of the gameport. This combination will result in a short of +5V to ground and cause a shutdown of the power supply.

To separate the shift-key and switch-2 functions to prevent shorting +5V to ground, perform the following procedure.

#### **Materials Required**

X-acto knife  
Digital multimeter

1. Locate the jumper pads marked X6 on the logic board (located to the left of the keyboard connector). Using the X-acto knife, cut vertically between the two jumper pads.
2. Use the ohmmeter to verify that the two jumper pads are not touching.



🍏 Apple Technical Procedures

# Apple IIe

## Illustrated Parts List

---

□ CONTENTS

- IPL.3 Finished Goods Assembly (Figure 1)
- IPL.5 Platinum Case and Extended Keyboard (Figure 2)
- IPL.7 Logic Board (Figure 3)
- IPL.7 Power Supply Switch (Figure 4)
- IPL.9 Power Supply (Figure 5)
- IPL.9 Spacebar Stabilizer Assembly (Figure 6)

The figures and lists in this section include all piece parts that can be purchased separately from Apple for the Apple IIe, along with their part numbers. These are the only parts available from Apple. Refer to your *Apple Service Programs* manual for prices.

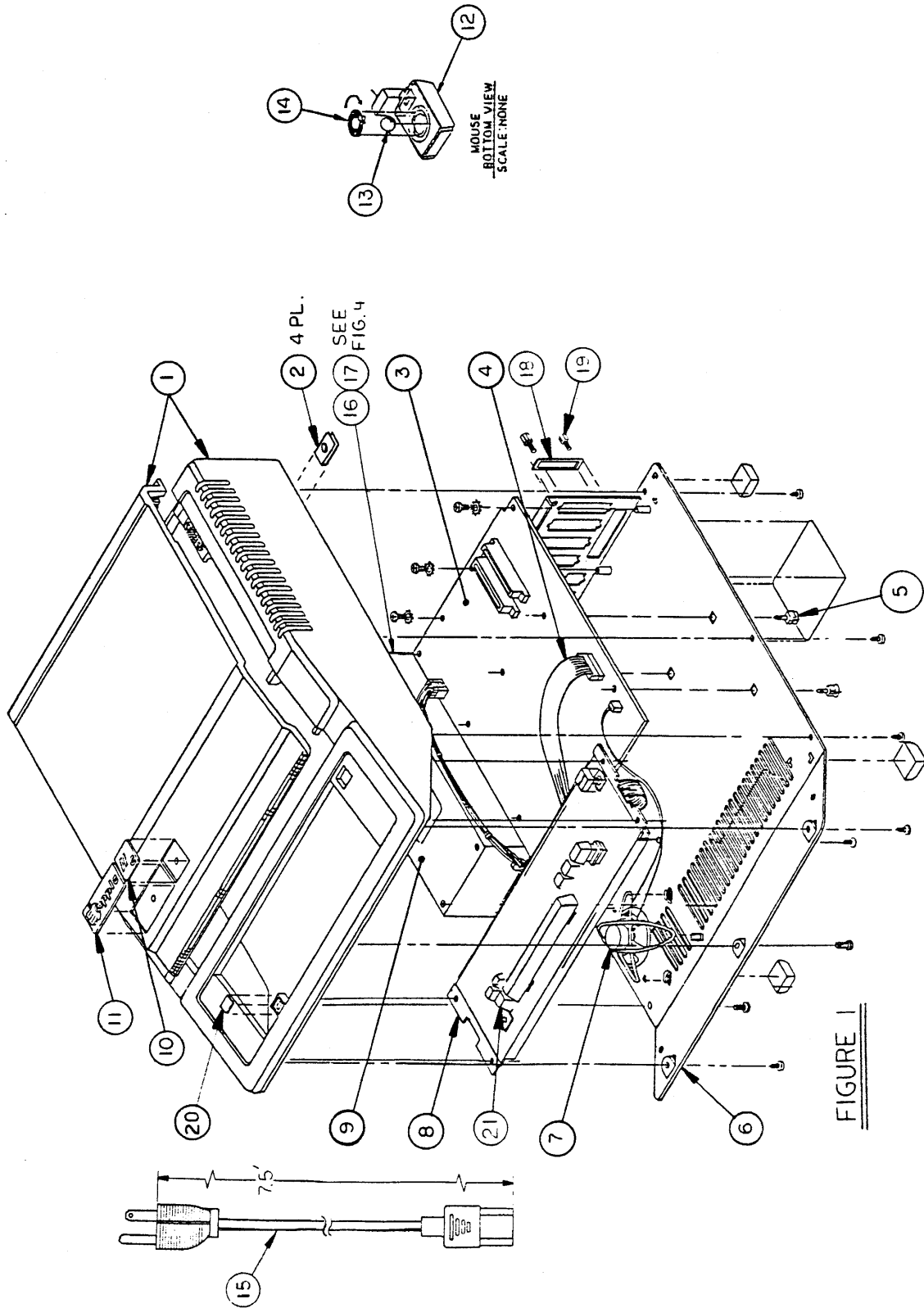

IPL.2 / Illustrated Parts List

rev. May 89

Apple IIe

□ **FINISHED GOODS ASSEMBLY (Figure 1)**

<u>Item</u>	<u>Part No.</u>	<u>Description</u>
1	076-0127	Case & Lid, Beige
2	835-0174	Nut, U-Type
3	661-91084	Logic Board
4	590-0108	Keyboard Cable
5	860-0044	Standoff, Platinum
6	810-0585	Base Pan
7	600-0009	Speaker Assembly
8	661-91085	Alps Long-Stem Keyboard
	661-95139	SMK Short-Stem Keyboard
	661-95233	SMK Long-Stem Keyboard
9	661-0455	Apple II, IIe Power Supply
10	825-0359	IIe Nameplate
11	825-0054	Apple Nameplate
12	661-0259	Apple II Mouse Assembly
	661-0400	AppleMouse, Platinum
13	699-8001	Rubber-Coated Mouseball
14	815-0409	Mouseball Retainer
15	590-0380	Power Cable, Smoke
16	705-0023	Switch, Power Supply, Rocker, Two-Pole
17	705-0065	Switch, Power Supply, Rocker, Three-Pole
18	805-0110	Plate, Nut, 25-Pin
19	835-0006	Screw, Hexagon Nut Plate
20	825-0352	Power-on Label
21	658-7045	Alps Keycap Set, Beige with Black

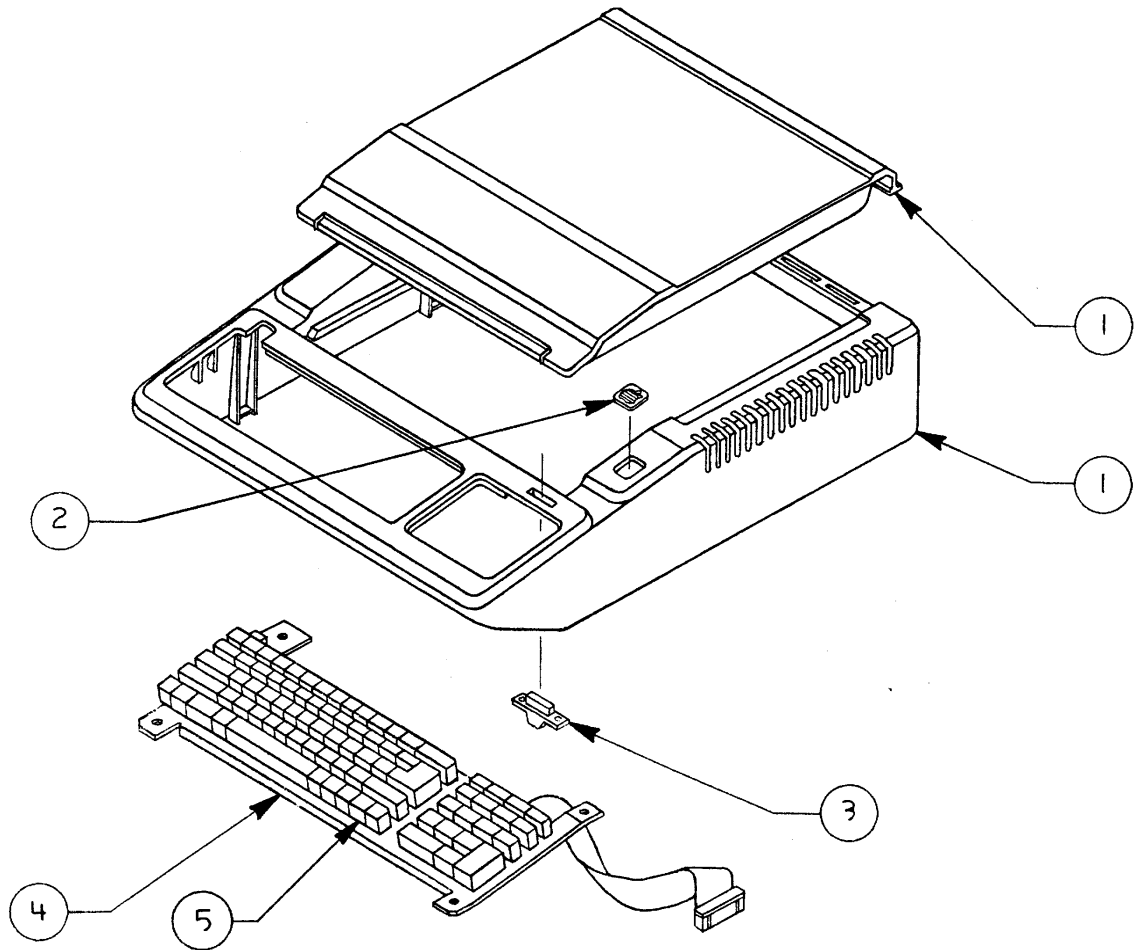

FIGURE 2

**□ PLATINUM CASE AND EXTENDED KEYBOARD (Figure 2)**

<u>Item</u>	<u>Part No.</u>	<u>Description</u>
1	607-5015	Case & Lid, Platinum
2	825-1340	Logo Label, Platinum
3	815-0586	Power-on Light Pipe
4	661-0357	Apple IIe Extended Keyboard, Platinum
5	658-7014	Apple IIe Keycap Set, Platinum

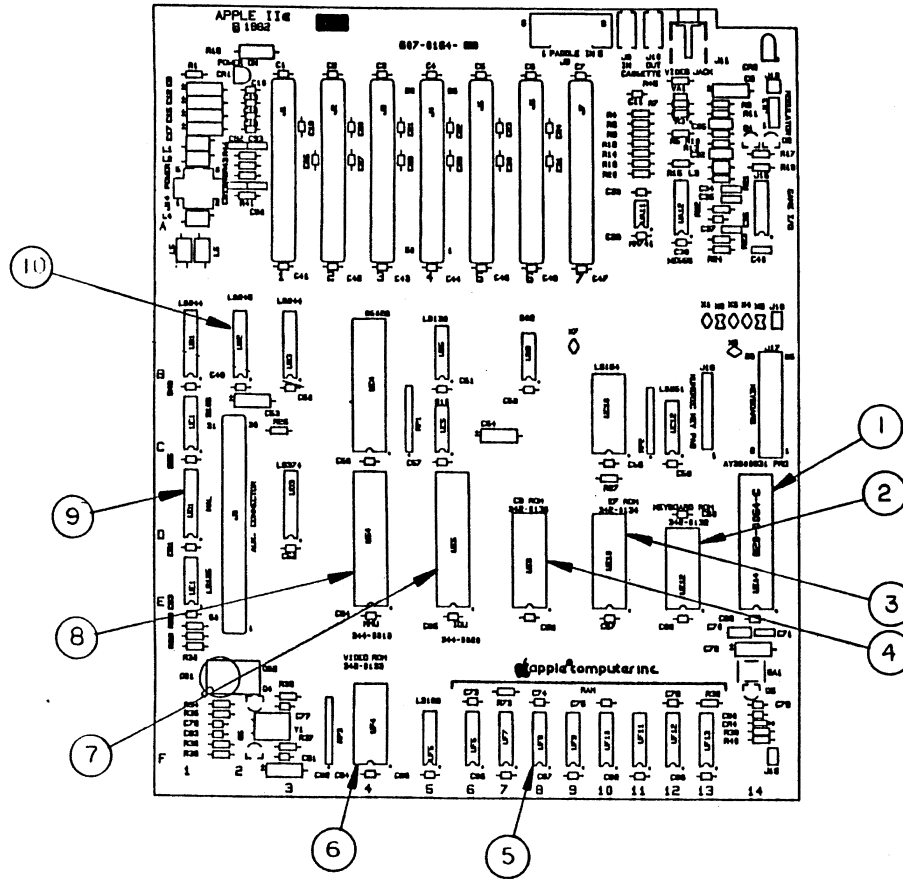

FIGURE 3

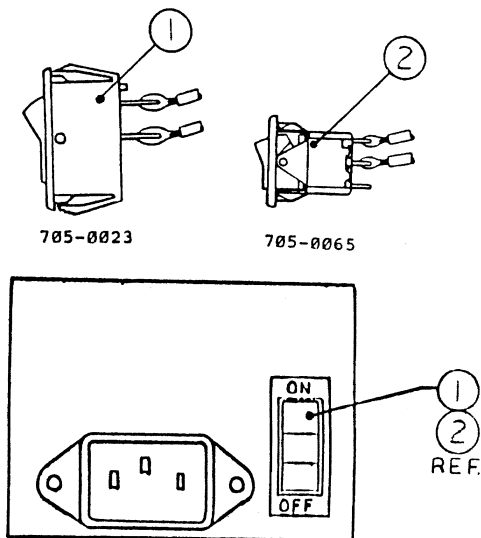

FIGURE 4

□ LOGIC BOARD (Figure 3)

<u>Item</u>	<u>Part No.</u>	<u>Description</u>
1	332-9600	IC, Keyboard Encoder
2	342-0132	IC, ROM 16K Keyboard
3	342-0134	IC, ROM 'EF' Firmware
	342-0303	IC, ROM 'EF' Enhanced Firmware
4	342-0135	IC, ROM 'CD' Firmware
	342-0304	IC, ROM 'CD' Enhanced Firmware
5	334-0003	IC, RAM 64K 200 NS w/Logo
6	342-0133	IC, ROM 32K Charc Gen
7	344-0020	IC, IOU
8	344-0010	IC, MMU
9	342-0170	IC, PAL 16R8
10	306-0245	IC, 74LS245

□ POWER SUPPLY SWITCH (Figure 4)

<u>Item</u>	<u>Part No.</u>	<u>Description</u>
1	705-0023	Switch, Power Supply, Rocker, Two-Pole
2	705-0065	Switch, Power Supply, Rocker, Three-Pole

**Note:** The items listed for the Power Supply Switch are also referenced in Figure 1 as well as Figure 4.

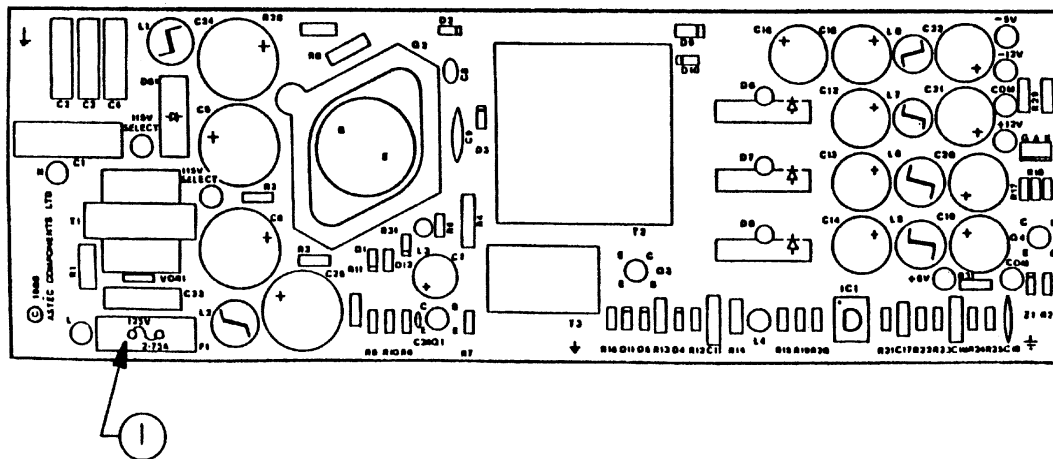

FIGURE 5

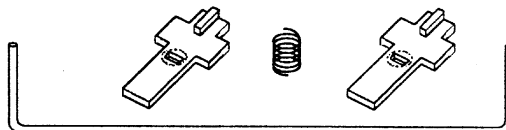

FIGURE 6



**□ POWER SUPPLY (Figure 5)**

<u>Item</u>	<u>Part No.</u>	<u>Description</u>
1	740-0001	Fuse, Power Supply, 1 Amp, 250V

**□ SPACEBAR STABILIZER ASSEMBLY (Figure 6)**

<u>Item</u>	<u>Part No.</u>	<u>Description</u>
-	076-8343	Spacebar Stabilizer Assembly (Consists of Stabilizer Bar, two Mounting Tabs, and four Springs)

The following keyswitches are illustrated in the Apple IIe product section, Appendix A, of your Technical Procedures Binder.

705-0015	Alps Short-Stem Keyswitch
705-0070	Alps Long-Stem Keyswitch
705-0075	SMK Short-Stem Keyswitch
705-0077	Alps Alpha Lock Keyswitch
705-0079	SMK Short-Stem Keyswitch
705-0080	SMK Caps Lock, Short Stem
705-0081	SMK Long-Stem Keyswitch
705-0082	SMK Caps Lock, Long Stem
705-0084	SMK Low-Friction, Long Stem
705-0085	SMK Low-Friction, Short Stem
815-0772	Straight Adapter
705-0044	Mitsumi Locking Keyswitch
705-0104	Mitsumi Keyswitch

**Apple IIe Technical Procedures**

**Section 6**

**Apple II Memory Expansion Card**

**Contents:**

Introduction.....6.3  
Things to Remember.....6.3  
Diagnostics and Troubleshooting.....6.4

## MEMORY CONFIGURATION CHART

256K RAM CHIP

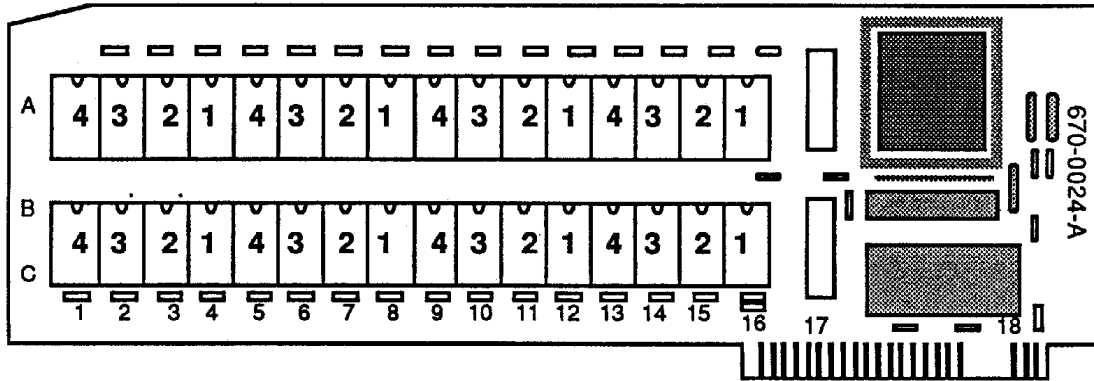
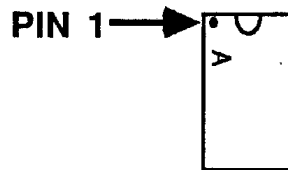

CARD SIZE	LOCATIONS OF 256K RAM CHIPS
256K	1
512K	1, 2
768K	1, 2, 3
1MB	1, 2, 3, 4

## INTRODUCTION

The Apple® II Memory Expansion Card can be used with any of the expandable personal computers in the Apple II family. This card allows you to use an additional 256K, 512K, 768K or 1 Megabyte of temporary storage when using the ProDOS® Operating System.

## THINGS TO REMEMBER

1. The Memory Expansion Card has ICs which are **HIGHLY SUSCEPTIBLE TO DAMAGE FROM ELECTROSTATIC DISCHARGE**. Ground yourself by touching the power supply case before picking up the Memory Expansion Card or installing it into any system. To further prevent any damage from electrostatic discharge, place the board in an anti-static bag before carrying it anywhere.
2. The Memory Expansion Card exchange modules are shipped **WITHOUT RAM**. All RAM ICs are considered a replaceable part. The 256K RAM is **SUSCEPTIBLE TO DAMAGE FROM ELECTROSTATIC DISCHARGE**. Touch the power supply case before handling or installing the RAM chips. **Remember to remove the RAM from the board you are sending to Apple. Bad RAM should not be sent in on the card.**
3. **The RAM has to be inserted in the correct sockets for the desired configuration.** Remember to place the dot or indentation on the chip in the correct direction for pin 1. Refer to the Memory Configuration Chart on the opposite page for the location and orientation of RAM.
4. Only Apple RAM should be used as replacement parts. (Apple RAM has the letter A near pin 1.)
5. The Memory Expansion Card works with the ProDOS Operating System. ProDOS automatically recognizes the card as a **RAMDISK**.
6. The Memory Expansion Card must be installed in slot 4, 5, or 6 to work with the Pascal Language System.
7. On the Apple IIe, the Memory Expansion Card can be installed in any slot except 3. On the Apple II Plus, the Memory Expansion Card can be installed in any slot except 0 (the Language Card must be installed there).
8. The Memory Expansion Card has no battery backup. The card is intended for temporary storage. Caution users to save their data often (every 15 to 20 minutes)!!

**DIAGNOSTICS AND TROUBLESHOOTING**

The Apple II Memory Expansion Card exchange module is shipped without socketed RAM. All socketed RAM must be removed before returning it to Apple.

**Materials Required**            Known-good Apple IIe  
    3.5-inch (or 5.25-inch) Disk Drive  
    Known-good RAM  
    Apple II Memory Expansion Card  
    Apple II Diagnostic Diskette

**Testing the RAM**

1. Install the Apple II Memory Expansion Card into any slot except 3.
2. Start up the Apple II Diagnostic Diskette (refer to **Section 2, Diagnostics**). Select the Apple II Memory Expansion Card Test and run the test.
3. Two types of failures are possible on the Apple II Memory Expansion Card:
  - a) If a RAM chip fails, coordinates on the board are shown on the screen. The top row of RAM has the coordinates A1 through A16. The bottom row of RAM has the coordinates C1 through C16.
    - 1) Locate the RAM and replace it with a known-good RAM chip.
    - 2) Retest the card.
    - 3) Repeat steps 1) and 2) until the card passes.
  - b) If the problem cannot be corrected by replacing a RAM chip, the screen will tell you to exchange the entire card.
    - 1) Remove all the RAM from the customer's card.
    - 2) Test the module being used for exchange using eight known-good RAMs.
    - 3) Install the customer's RAM into the new module.
    - 4) Retest the card.
    - 5) Return to the beginning of this step until the card passes.

**Apple IIe Technical Procedures**

**Appendix A: Keyboard and Keyswitch Identification**

There are several different types of keyswitch used in Apple IIe keyboards. To replace a faulty keyswitch, you must match the old keyswitch with a new one of the same type.

This procedure contains a chart with drawings and part numbers of all IIe keyswitches, listed by keyboard type. Before you use the chart, read the following background information on keyboards and keyswitches.

**BACKGROUND INFORMATION: Keyboard and Keyswitch Differences**

There are five main types of Apple IIe keyboard: Alps long stem, Alps short stem, SMK long stem, SMK short stem, and Mitsumi. On each keyboard, most keys have the standard ("alphanumeric") keyswitches shown below. (Special keyswitches are used for Caps Lock, Reset, and some other function keys. Refer to Figure 2, later in this procedure, after you know which type of keyboard you have.)

**Stems: Short vs. Long, Flat vs. Round**

"Short stem" keyswitches use adapters, small plastic pieces (usually white) that fit on the stem to make it longer. The keycap sits on the adapter.

"Long stem" keyswitches (and Mitsumi keyswitches) are capped directly with the keycap.

Alps and Mitsumi keyswitches have flat stems. SMK keyswitches have round stems, as you can see in the figure below.

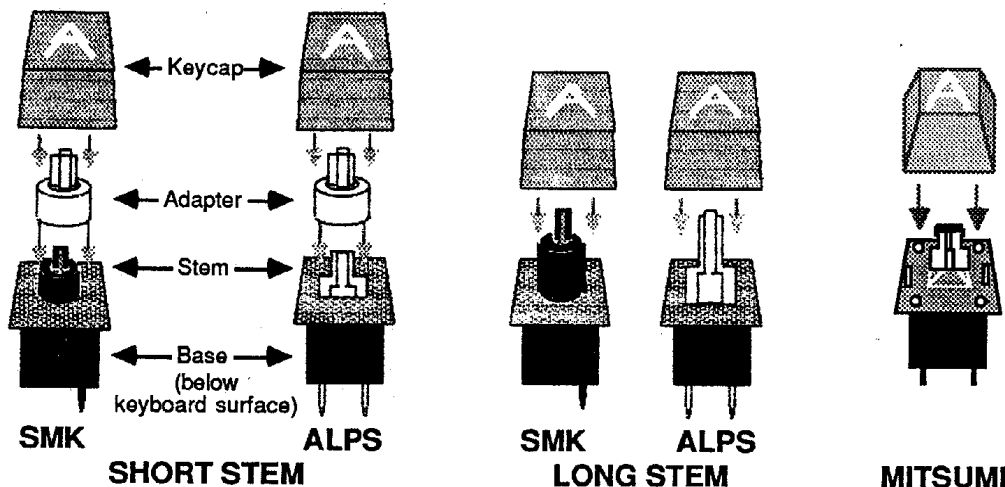

**TO IDENTIFY IIE KEYBOARDS AND KEYSWITCHES:**

1. Pry off the keycap with a small screwdriver so that you can see:
  - a) whether the keyswitch uses an adapter.
  - b) whether the lower part of the stem is flat or round.
2. If the keyswitch is flat and has no adapter, it could be either Alps long stem or Mitsumi. To determine which it is, examine the CAPS LOCK keyswitch. If there is a spring around its stem, it is Alps long stem; if not, it is Mitsumi.
3. Use the table below to identify the general type of keyswitch (Alps, SMK, or Mitsumi; long stem or short stem). Then use Figure 2 (next two pages) to identify the exact keyswitch needed.

**TABLE 1**

KEYSWITCH TYPE:	SMK Short Stem	SMK Long Stem	Alps Short Stem	Alps Long Stem	Mitsumi
Stem shape (lower part of stem)	Round	Round	Flat	Flat	Flat
Keyswitch uses adapter?	Y	N	Y	N	N
Caps lock key has spring?				Y	N





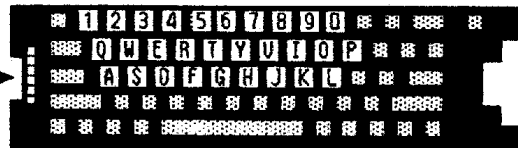

4. Plate numbers: You can also identify standard Apple IIE keyboards (without numeric keypad) by finding the plate number on the black metal keyboard plate. After you remove the keyboard from the computer, locate this number on the top left edge of the plate (see Figure 1, #1). (The Mitsumi keyboard has no plate number.) Then find the plate number in the right column of Figure 2, and look in the left column to find the exact keyswitch.

**FIGURE 1:  
PLATE NUMBER**







TOP VIEW OF REMOVED KEYBOARD

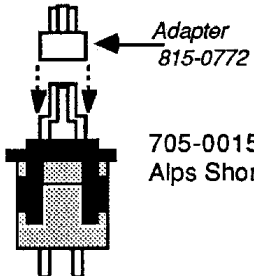

KEYSWITCH	PLATE NUMBER ON KEYBOARD
<p style="text-align: center;"><b>A. SMK Long Stem</b></p> <div style="display: flex; justify-content: space-around;"> <div style="text-align: center;">  <p>705-0081 SMK Long Stem</p> <p>Alphanumeric keys</p> </div> <div style="text-align: center;">  <p>705-0084 SMK Low Friction Long Stem</p> <p>Used for Spacebar, Shift; sometimes for Tab, Ctrl, Delete, Return.</p> </div> </div> <div style="display: flex; justify-content: space-around; margin-top: 20px;"> <div style="text-align: center;">  <p>705-0079 SMK Short Stem</p> <p>Reset</p> </div> <div style="text-align: center;">  <p>705-0082 SMK Caps Lock ("Alternate Action") Long Stem</p> </div> </div>	<p>805-0199</p>
<p style="text-align: center;"><b>B. SMK Short Stem</b></p> <div style="display: flex; justify-content: space-around; margin-bottom: 20px;"> <div style="text-align: center;">  <p>← Adapter 815-0772</p> <p>705-0079 SMK Short Stem</p> <p>Alphanumeric keys; also used as Reset key (without adapter)</p> </div> <div style="text-align: center;">  <p>← Adapter 815-0772</p> <p>705-0085 SMK Low Friction Short Stem</p> <p>Used for Spacebar, Shift; sometimes for Tab, Ctrl, Delete, Return.</p> </div> </div> <div style="text-align: center;">  <p>705-0080 SMK Caps Lock ("Alternate Action") Short Stem</p> </div>	<p>805-0192</p>

**FIGURE 2: APPLE IIe KEYSWITCHES** (continued on next page)

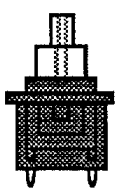

KEYSWITCH		PLATE NUMBER ON KEYBOARD
<b><u>C. Alps Short Stem</u></b>		
 <p>Adapter 815-0772</p> <p>705-0015 Alps Short Stem</p>	 <p>705-0077 Alps Alpha Lock ("Alternate Action")</p>	805-0195
<b><u>D. Alps Long Stem</u></b>		
 <p>705-0070 Alps Long Stem ("Extended")</p>	 <p>705-0077 Alps Alpha Lock ("Alternate Action")</p>	805-0182
<b><u>E. Mitsumi</u></b>		
 <p>705-0104 Mitsumi Keyswitch</p>	 <p>705-0044 Mitsumi Locking Keyswitch</p>	(none)

**FIGURE 2: APPLE IIe KEYSWITCHES**

## Apple IIe Technical Procedures

### Appendix B

#### Apple II Plus and Apple IIe: Differences

The question most often asked is, "What are the differences between the Apple II Plus and the Apple IIe?" When you look at the systems, several differences are apparent, such as the layout of the keyboard and the addition of keys for the Apple IIe. With these new keys additional functions can be performed.

You can see other differences when you remove the cover. First, many of the options for the Apple II Plus are standard on the Apple IIe, such as a built-in language card. The Apple IIe has only 31 chips, the language card is built-in, and there is an auxiliary slot for an 80 column card. Not visible is the fact that the Apple IIe runs self-diagnostics when the system is booted.

A table of the differences between the Apple II Plus and the Apple IIe is shown on the following page.

**APPLE II PLUS AND APPLE IIe: DIFFERENCES**

	<b>Apple II Plus</b>	<b>Apple IIe</b>
CPU	6502	6502A
Main Memory	48K expandable to 64K (110 ICs)	64K expandable to 128K (31 ICs)
Graphics Capabilities	Hi-Res capability	Double Hi-Res can be added
Keyboard	Upper case 51 keys No auto repeat	Upper/lower case 63 keys Auto repeat
Arrow keys	Use i,j,k,m	right, left, up, down
Screen display	40 characters/line	40 characters/line; can be extended to 80
Expansion	8 expansion slots (0 - 7)	8 expansion slots - 7 general purpose - auxiliary 80 column
Operating system	DOS	DOS 3.3, ProDOS®
Built-in Language (in ROM)	Applesoft BASIC	Applesoft BASIC
Languages Available	Auto-start Monitor (in ROM), Integer BASIC, Pascal, FORTRAN, C/S, COBOL, Pilot, Logo, many others	Same as Apple II Plus
Expansion Cards	Language card (16 byte expansion memory), Integer BASIC firmware, hobby prototyping cards, Memory Expansion card, and others	80 column text card, Extended 80 Column card, Memory Expansion card, and others
Interface Cards	Super Serial Interface Parallel Interface IEEE 488 Interface	Super Serial Interface Parallel Interface IEEE 488 Interface



Apple II



Apple IIe  
(late model)



Apple IIc

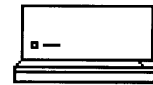

Apple IIGS



Disk II



Apple III

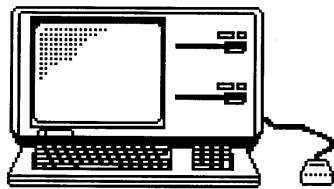
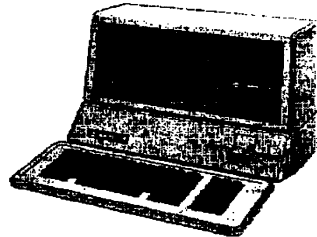

Lisa



Lisa 2

# End of Apple Service Repair Information

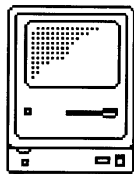

Macintosh 128

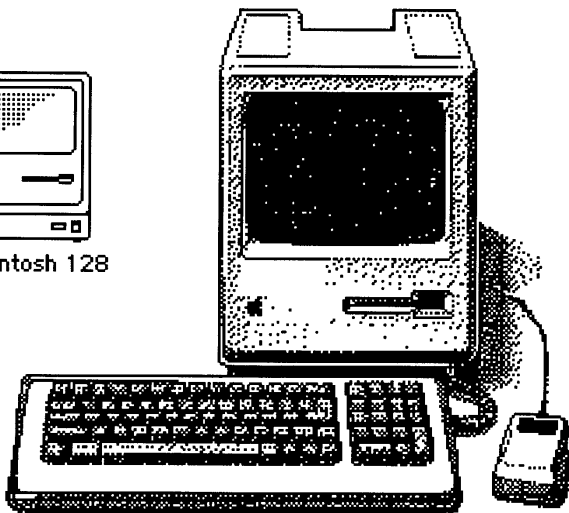

Macintosh Plus

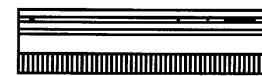

Macintosh II

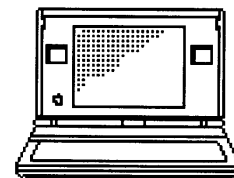

Portable Macintosh

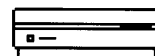

Macintosh LC